

Come, experience the Haier Water Heater advantage today.

Constant innovation is a commitment for us at Haier, so that we bring to you solutions that transform your life. Every water heater we produce, is a product of years of research, cutting-edge technology and precision manufacturing. So that what you get is a simply advanced product, offering you the best value.

**No.1**\*

Haier is the number one electric storage water heater company in the world, with a market share of 20% in terms of retail volume sales in 2019



**International  
Quality**

Built to exacting standards, our products have won numerous awards and accolades for quality and performance worldwide. Now, experience the same here too.

**Maximum  
WARRANTY**

Every product at Haier is backed by a warranty ensuring your trust in us remains intact.



**Prompt After  
SALE SERVICE**

With a strongest dealer network across the country and our 24 hour helpline, you get the assurance of a quick response every time.



**Energy Saving**

We're committed to a greener environment and hence all our products are built to conserve energy. Helping you save in more ways than one.

Dealer Stamp

**Haier** 1800-200-9999  
CUSTOMER CARE 1800-102-9999 Toll Free - 24x7

Features may vary from model to model. As a continuing policy of product improvement at Haier Appliances, the design and product specifications are subject to change without prior notice.

**Haier**  
Inspired Living

Haier Appliances India Pvt Ltd, Plot No.1, Okhla Industrial Estate, Phase-3, New Delhi - 110020  
Tel: 011-39496000/30674000, Fax: 011-26971562  
Email: info@haierindia.com, Website: www.haier.com/in/ www.facebook.com/haierindia

Conditions Apply\*\*

**Haier**  
Inspired Living

**World's No.1**\*  
**Safe-Health-Quality**



**Shock Proof**



**WATER HEATER  
CATALOGUE**

Global No.1 in 2019

# No.1\*

## Haier Water Heater

Haier water heater, since their launch in India have taken the market by storm. Perfectly designed for Indian conditions and keeping the requirements of the modern customer in mind. Haier water heater combine safety and convenience in an attractive design. Be it the unique shape or features like the cordless remote water heater, Haier is unsurpassed in its performance.

If it is Haier Water Heater, then rest-assured it is safe. Safety has been the fundamental feature of this product and will continue to be its forte in the years to come.

Haier water heater, since their launch in India have taken the market by storm. Perfectly designed for Indian conditions and keeping the requirements of the modern customer in mind. Haier water heater combine safety and convenience in an attractive design. Be it the unique shape or features like PATENT SHOCK-PROOF technology, Haier is unsurpassed in its performances.

Haier has put up a new Water Heater manufacturing facility at Pune, Maharashtra with a production capacity of 5, 00,000 units for Electrical water heater and 1,00,000 units of Solar water heater.

Our R & D facilities are continually exploring new technologies to make our product more safe, energy efficient & user friendly.

### In the markets of :

China, Austria, Belarus, Belgium, Bulgaria, Czech Republic, France, Germany, Hungry, India, Italy, Japan, Kazakhstan, Libya, Morocco, Poland, Romania, Russia, Serbia, Slovakia, South Korea, Spain, Switzerland, Tunisia, Turkey, UAE, UK, Ukraine, USA and Vietnam

ISO9001 & 14001

Certification



CNAS



Solar-Keymark



SP-certification



AS/NZS 2712



TSU-certification



CESI  
NF CESI



Water Mark



SABS

**92% OF INDIAN HOUSE HOLDS DON'T HAVE PROPER SAFETY PARAMETERS IN THE BATHROOM, WHICH HAS PROVEN\* TO BE LIFE THREATENING ENVIRONMENT, WHICH SERIOUSLY THREATENS THE SAFETY OF LIFE.**

According to a third-party electricity environment safety survey data, which was conducted in 2018, across 9 cities. In India, among **691** households, **92%** of households face a potential risk of an electricity shock due to inadequate safety parameters, Only **8%** are safe.

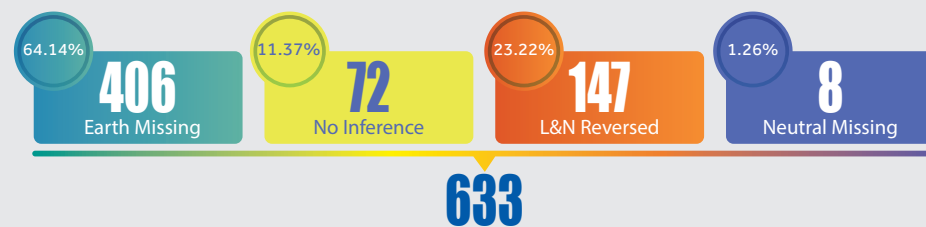

### Survey Results of Electricity Consumption Environment in 9 Cities in India

City	Correct	Incorrect			
	/	Earth Missing	No Inference	L&N Reversed	Neutral Missing
Bangalore	20	52	16	0	0
Chandigarh	0	5	0	65	0
Coimbatore	25	35	0	4	7
Dehli	0	83	0	1	0
Jaipur	3	38	14	12	0
Mumbai	4	49	38	8	0
Pune	0	71	0	0	0
Rajkot	2	69	3	2	0
Vijayawada	4	4	1	55	1
<b>Total</b>	58	406	72	147	8
	▶ 58		▶ 633		
	▶ 8%		▶ 92%		

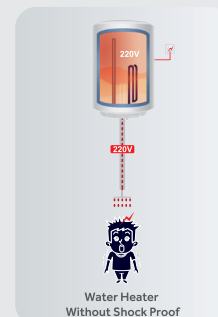

Water Heater Without Shock Proof

Bad electricity environment seriously affects the safety of life! Use of electricity in the harsh environment, even qualified products fail to guarantee the safety of electricity use, which may even threaten the life.



### HAIER WATER HEATERS COME WITH PATENT SHOCK PROOF TECHNOLOGY TO ENSURE YOUR LIFE SAFETY.

**WORLD'S NO.1 CERTIFICATE**

Haier Shock Proof Water Heater

**Shock Proof**

The only water heaters that can ensure users' safety under all conditions

- ✓ No earthing cases
- ✓ Faulty earthing cases
- ✓ All other current leakage cases

90 MILLION FAMILIES **NO ACCIDENT**

**900000000**

PATENT NO. : 218247

### Haier Shock Proof Water Heater Global No.1 Manufacturer & Seller

Market claim for Haier's market position in the world's electric water heater market. Haier is the number one electric storage heater company in the world with a market share of 20% in terms of volume sales in 2019. Global No.1 electric water heaters sales for 11 consecutive years.



**ES15/25V-SD WIFI**



Shock Proof



WIFI



APP Application



Remote Control



iBPS



LED Display



Voltage Fluctuation Proof



Smart Memory



**ES15/25V-SD**



**ES15/25V-S1**



BPS



ABS



UMC Tank



Incoloy 800SS Heating Element

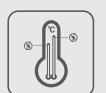

TTS Technology



8 Bars Rated Pressure



RSC Technology



**ES15/25V-I4**

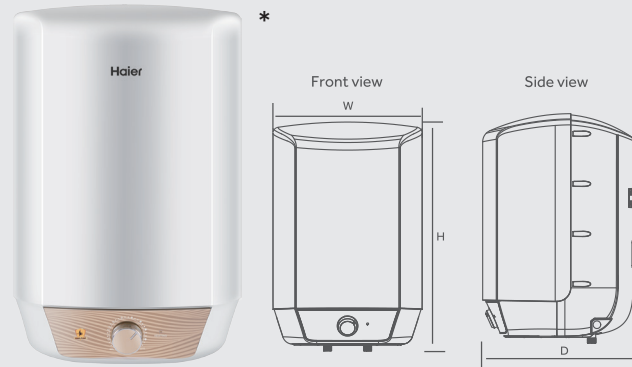

**ES15/25V-N4**



Shock Proof



BPS

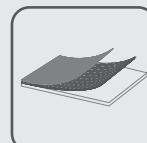

UMC Tank



Incoloy 800SS Heating Element



8 Bars Rated Pressure



Water Proof

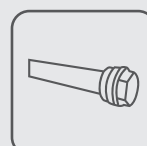

Magnesium

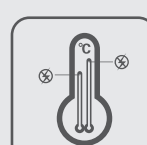

TTS Technology

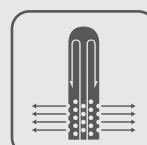

RSC Technology

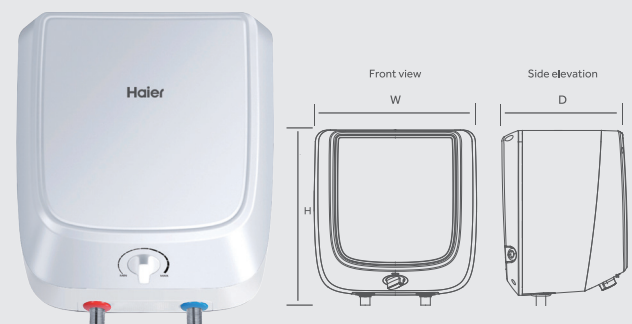

**ES10V-Q1**

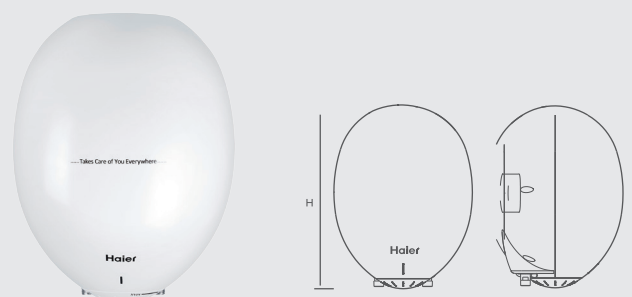

**ES6V-Q2**

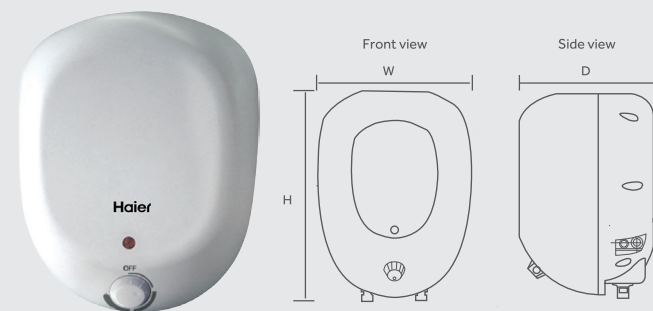

**ES6V-Q1**



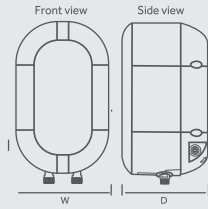

### ES3V-C1(I/W)

\*Shock Proof is not applicable in 3 lit WH



Shock Proof



ABS



Flower PCM



Incoloy 800SS Heating Element



8 Bars Rated Pressure



Water Proof



UMC Tank



TTS Technology



Voltage Fluctuation Proof

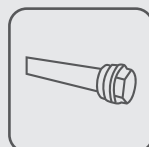

Magnesium

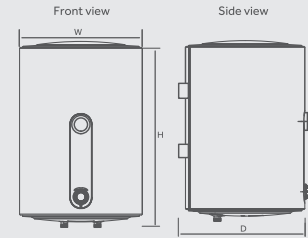

### ES10/15/25V-T1



Shock Proof



PCM

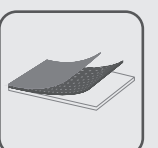

UMC Tank

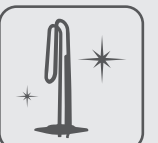

Incoloy 800SS Heating Element



8 Bars Rated Pressure



Water Proof

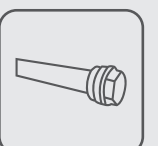

Magnesium

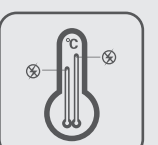

TTS Technology

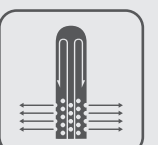

RSC Technology

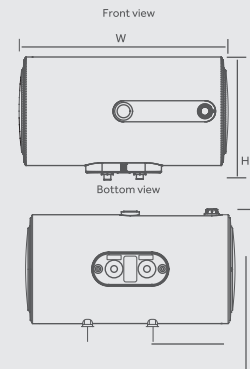

### ES15/25H-T1



Water Proof

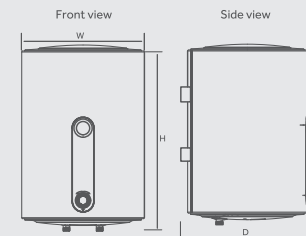

### ES10/15/25V-E1

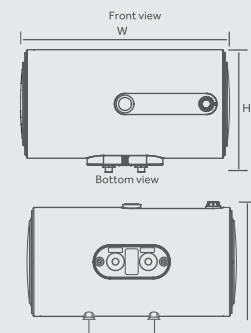

### ES15/25H-E1



